



# Dinosaur Electronics

1160 SE 27th St.  
Lincoln City, OR 97367  
Ph. (541) 994-4344 Fax: (541) 994-2796

## INSTALLATION INSTRUCTIONS FOR THE MICRO P-1338

Important! Before installing your new MICRO P-1338, you should take a couple of minutes to carefully inspect the refrigerator wiring and the old board for damage.

This not only protects the new board, but can save you a lot of troubleshooting time.

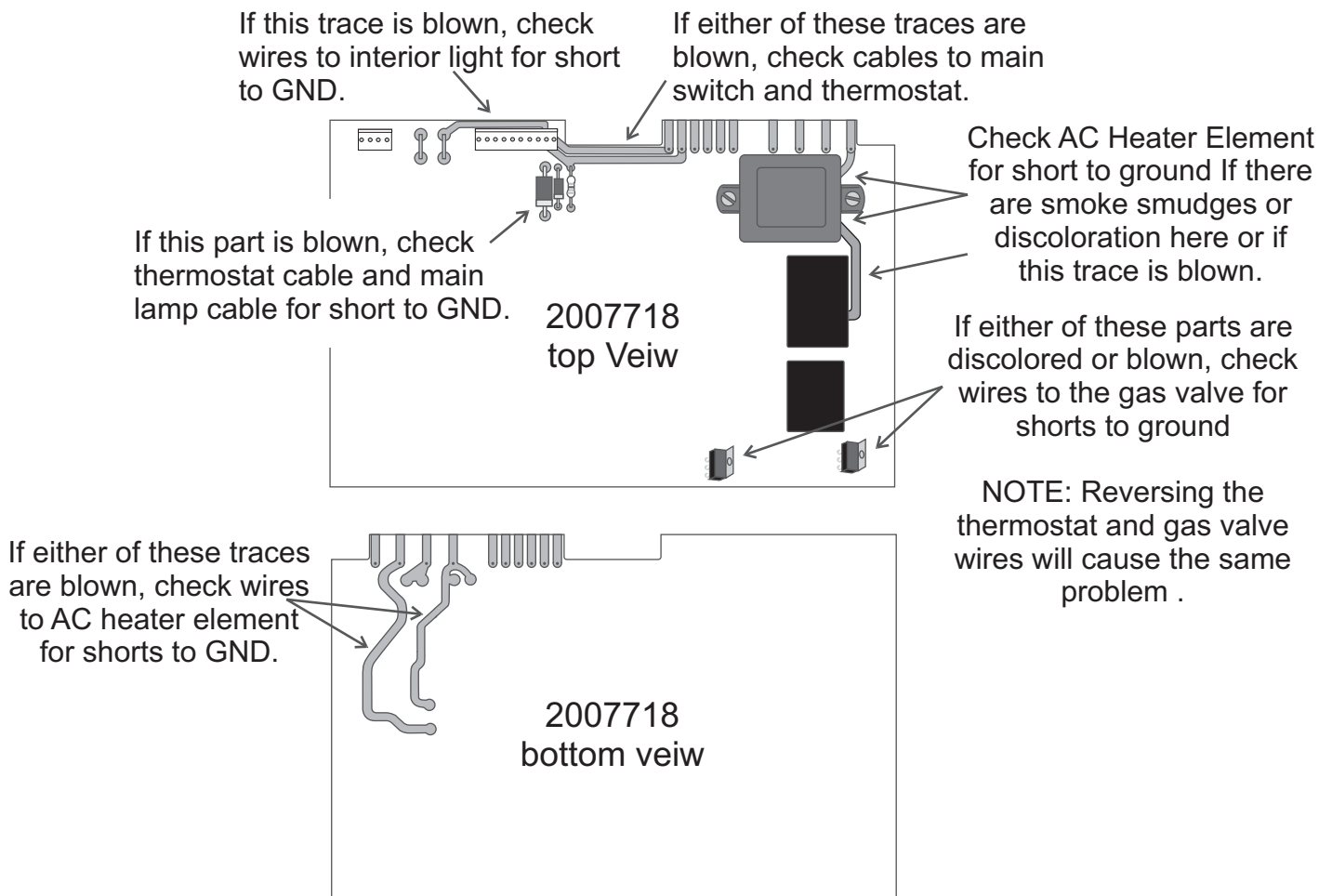

# INSTALLING THE MICRO P-1338

If either of these two parts are discolored or blown, check wires to gas valve for short to GND.

If this trace is blown, check AC Heater Element for short to GND.

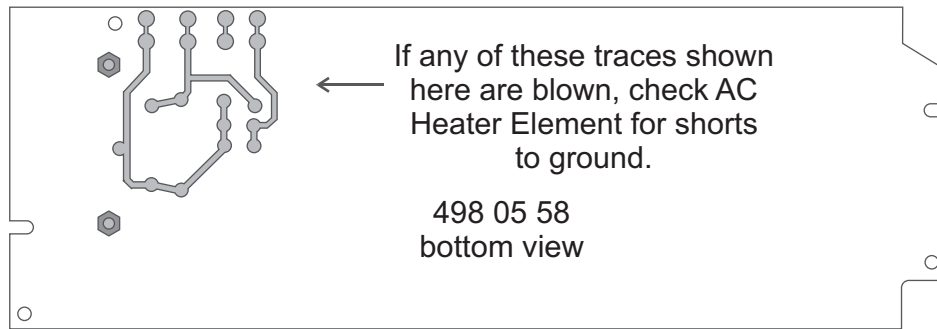
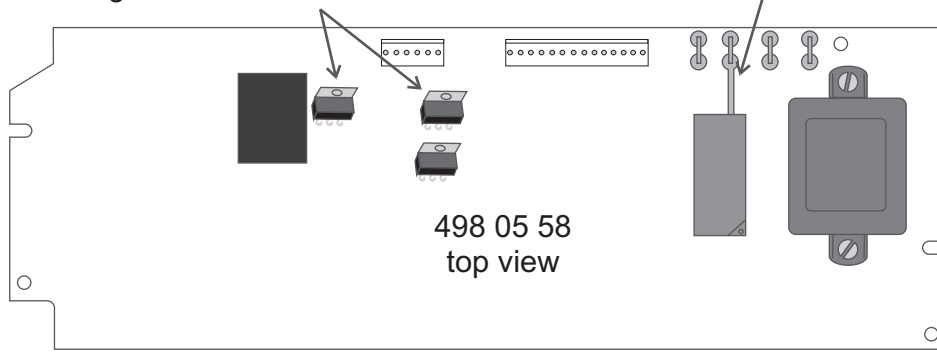

If this part is discolored or blown, check polarity of the 12v DC wiring to refrigerator

If either of these traces are blown, check AC Heater Element for shorts to ground.

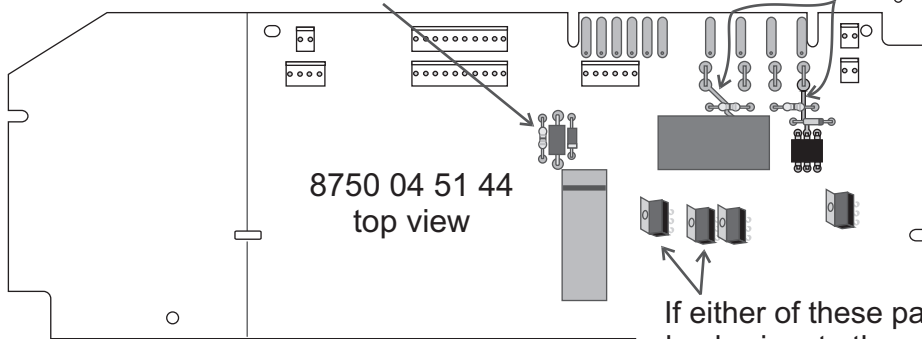

If either of these parts are discolored or blown, check wires to the gas valve for shorts to ground  
NOTE: Reversing the thermostat and gas valve wires will cause the same problem and so will plugging the gas valve wires into the wrong row.

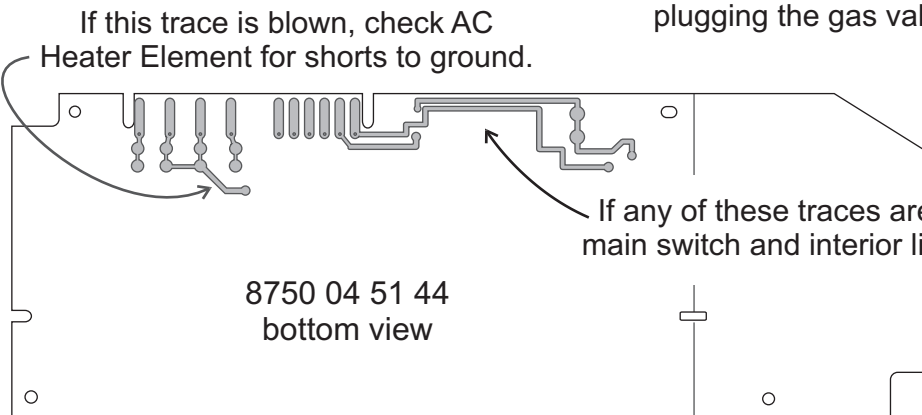

# INSTALLING THE MICRO P-1338

IN DOMETIC'S REFRIGERATOR MODELS:  
RM663, RM763, RM1303

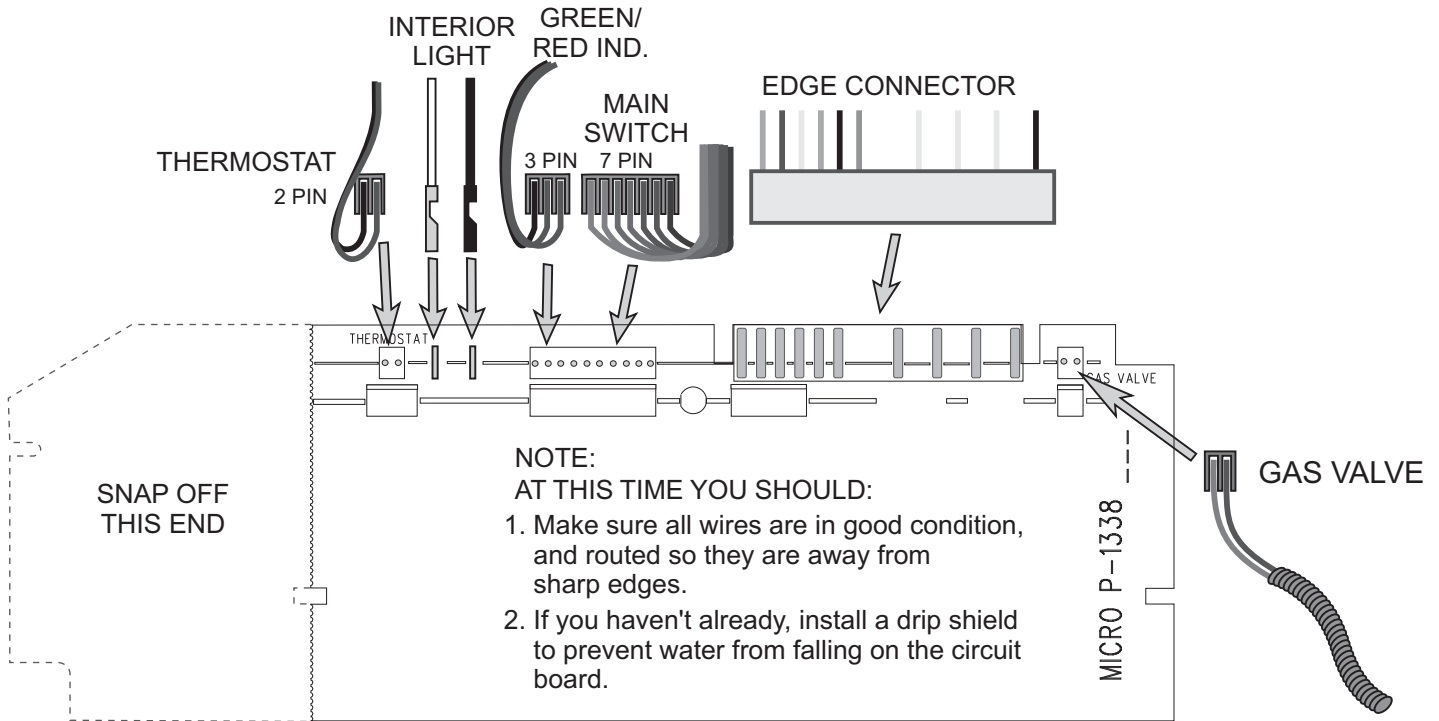

CONNECTORS GO ON LIKE THIS.

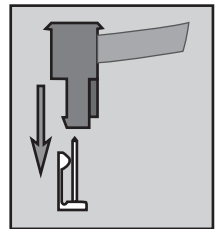

IN DOMETIC'S REFRIGERATOR MODELS:  
RM 3500, RM 3600, RM 3800

