



Dinosaur Electronics

1160 SE 27th St.

Lincoln City, OR 97367

Ph. (541) 994-4344 Fax: (541) 994-2796

INSTALLING THE 2-way MICRO P-24

Important!: The actual color of the wires may be different!

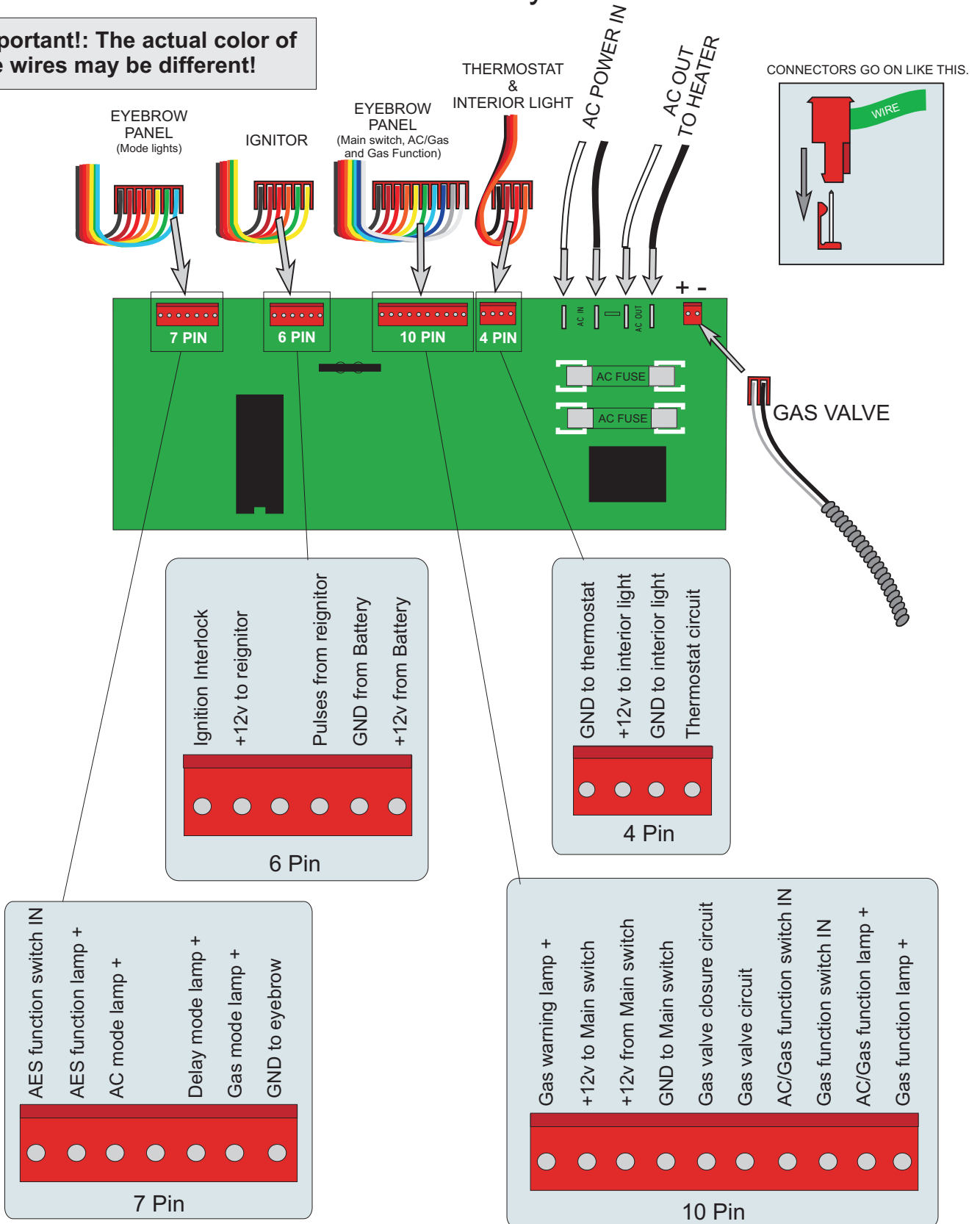

CONNECTORS GO ON LIKE THIS.

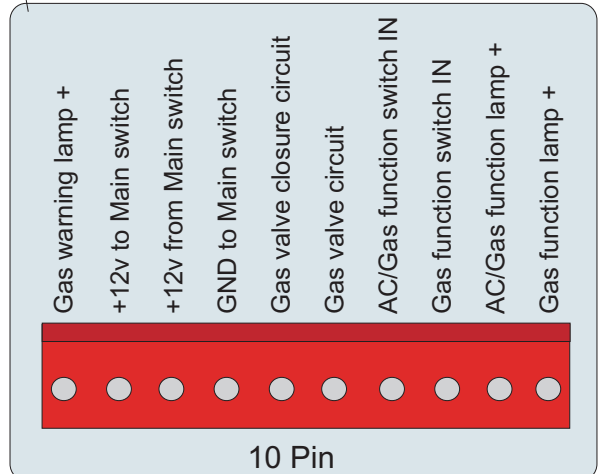
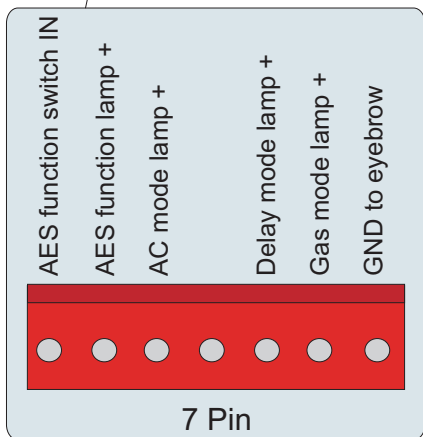
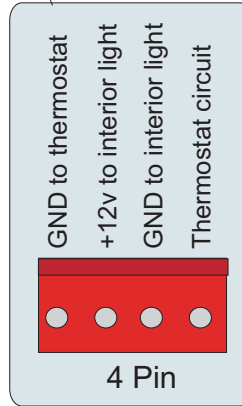
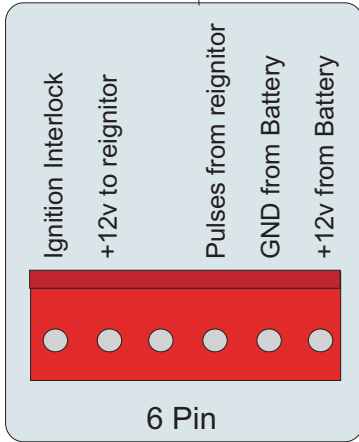
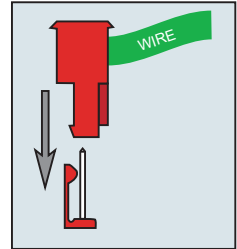

Owner's Information Sheet

(Please give this to the owner of the refrigerator.)

Operating Instructions

General operation: Absorption refrigerators operate by using a flame or electric heating element to drive a convective refrigeration cycle that moves heat from the inside of the refrigerator to the outside. This cycle first cools the freezer compartment, and then the refrigerator compartment is cooled by what is left over. There is no individual control over each compartment, and the controls are set to give the desired temperature in the refrigerator compartment. This cycle can last from 30 minutes to several hours, and the heat sources (flame or AC element) are on full during the cycle.

The temperature control then turns off the heat source when the desired refrigerator temperature is reached. Until the temperature inside the refrigerator rises several degrees, the control board will maintain the lights and monitor the switch positions, but all heat sources will be off.

AC operation: With the coach plugged in to shore power, select AES or AC/Gas on the eyebrow control. The AC element will cycle on and off to maintain the desired temperature inside the refrigerator. If the refrigerator will not switch to AC operation, replace the 5 Amp fuses (2 glass 3AG fuses located under blue vinyl covers.)

Gas operation: Unplug from shore power or set the eyebrow control to the Gas Function. The reignitor will produce sparks, the gas valve will open, and the flame will stay lit until the thermostat is satisfied. If the tow vehicle engine is turned off, the gas operation will be turned off for about 30 minutes and the "wait" mode lamp will be lit.

If the gas runs for about 2 minutes, then turns off and the CHECK light comes on, verify that you have propane, and check the burner for rust flakes from the flue. If the CHECK light comes on after about 10 seconds, clean the ceramic insulator on the spark electrode. If this does not solve the problem, replace the reignitor.

Refrigerator board troubleshooting

2-way MICRO P-24

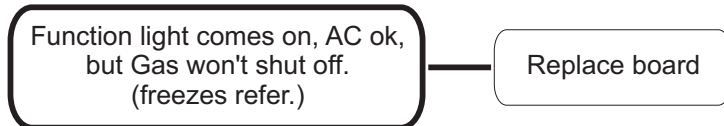
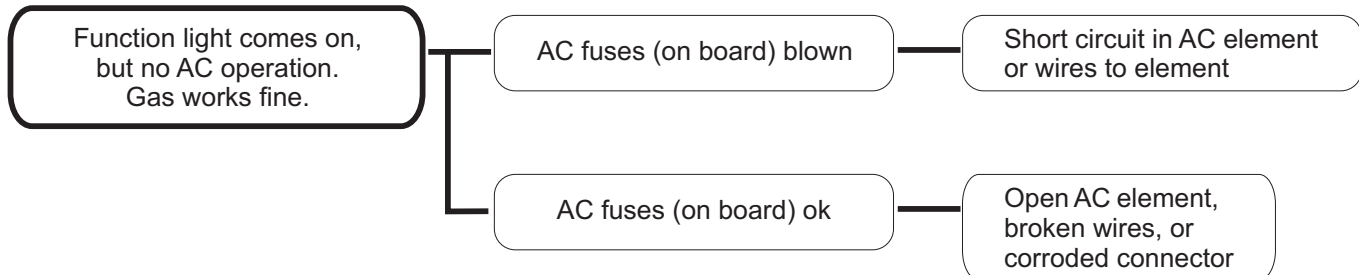
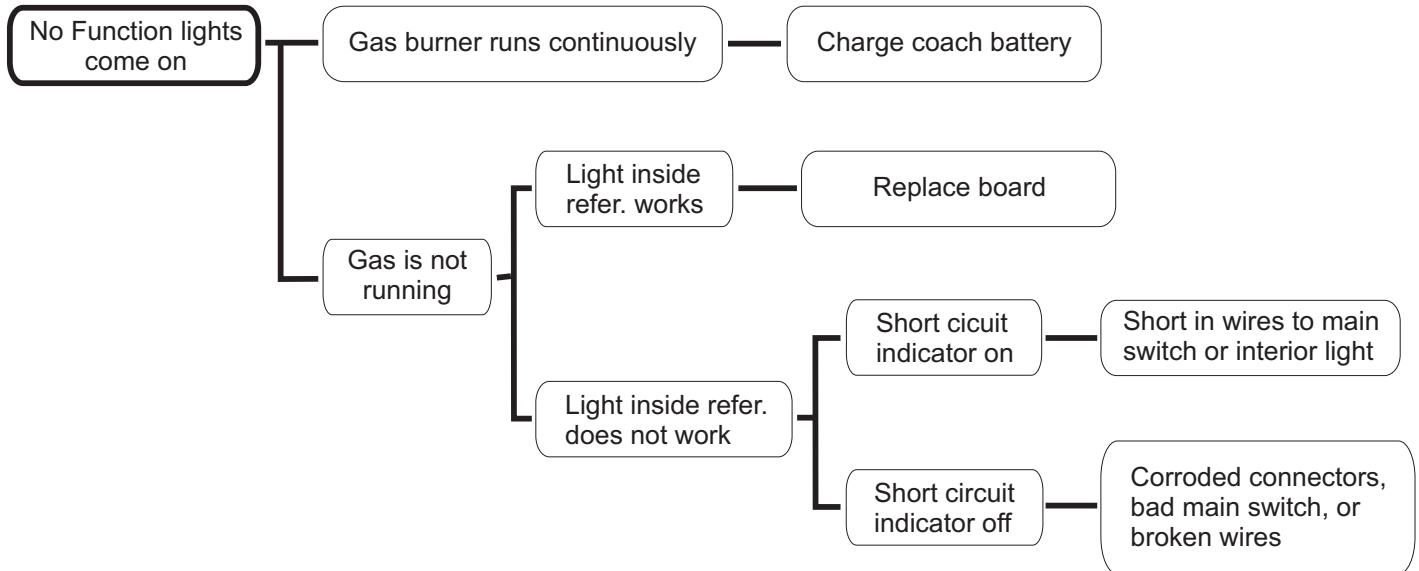

Refrigerator board troubleshooting (continued) 2-way MICRO P-24

